

ISSUE	DATE	AMENDMENTS
1	21/12/11	ORIGINAL
2	13/02/12	1ST PRODUCTION BUILD UPDATES - WDA
3	12/12/12	HEATERS CHANGED TO PTC HEATERS - WDA

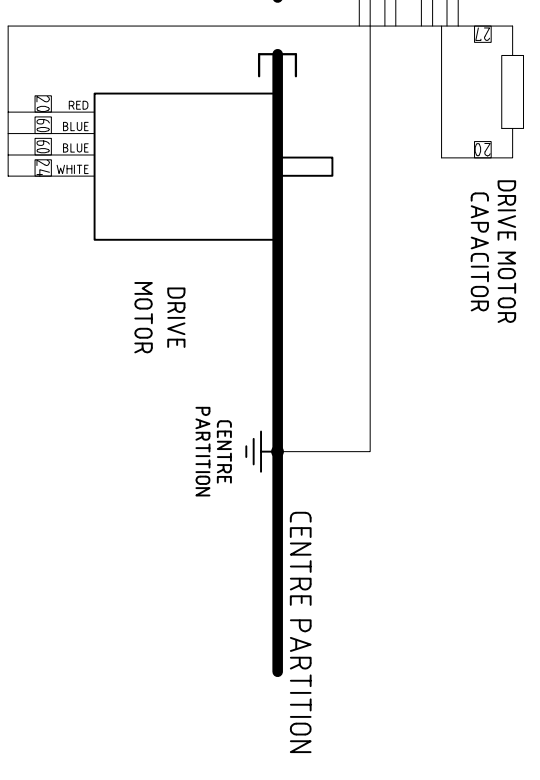
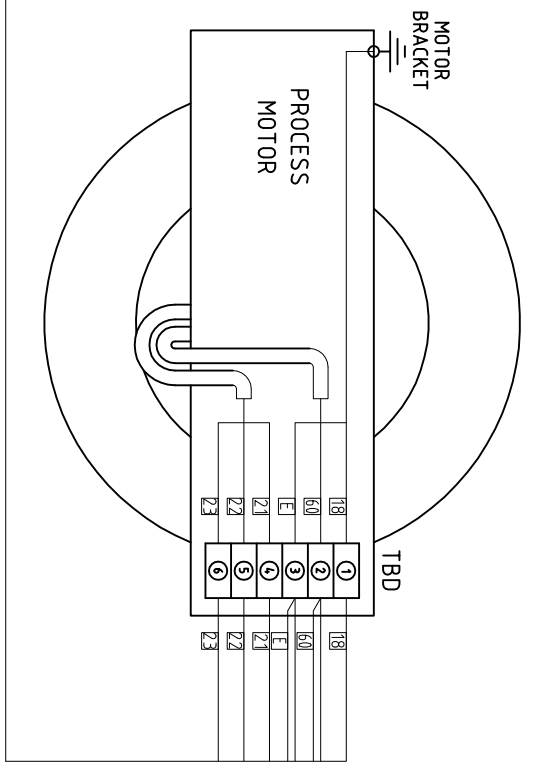
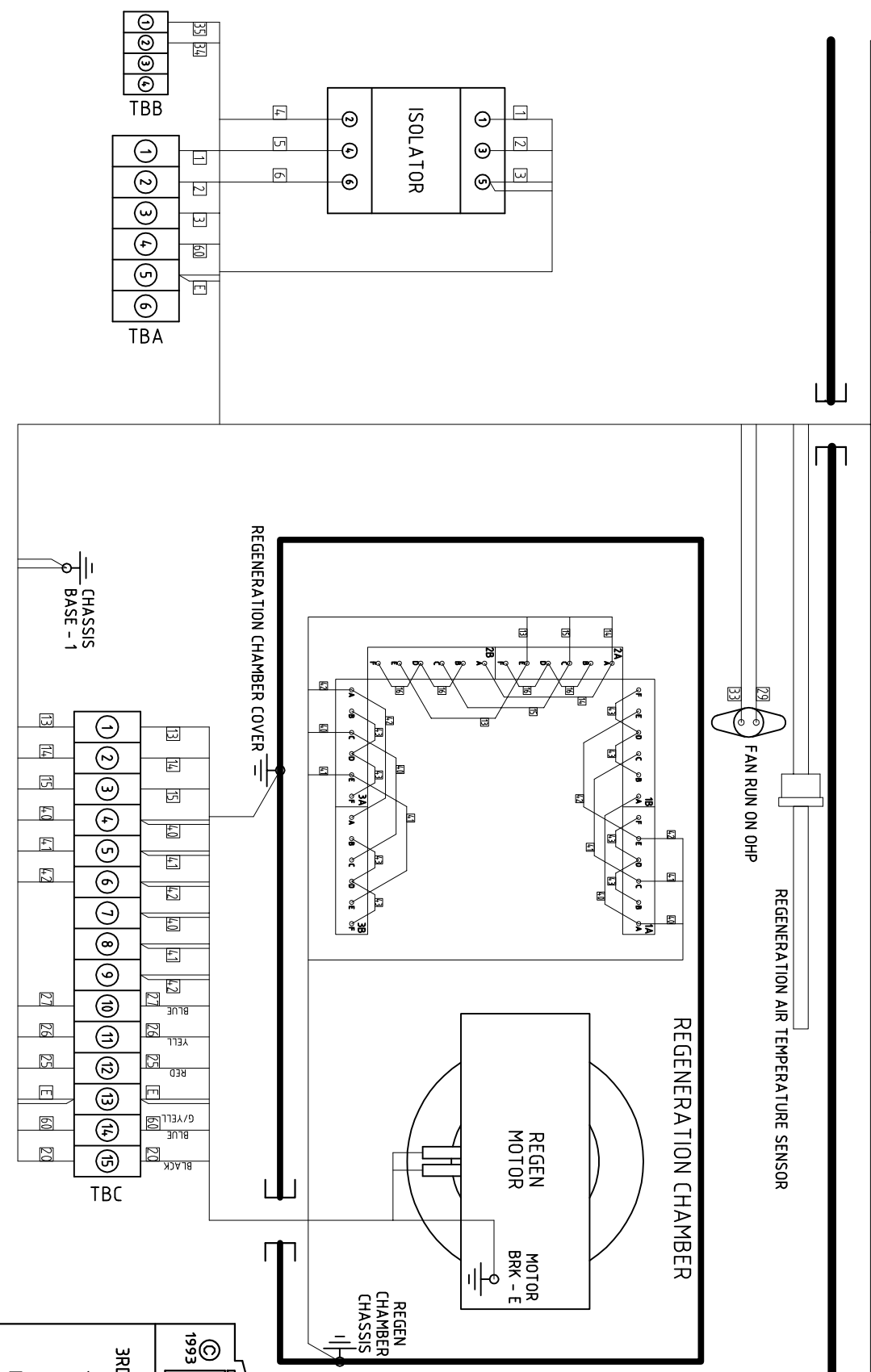
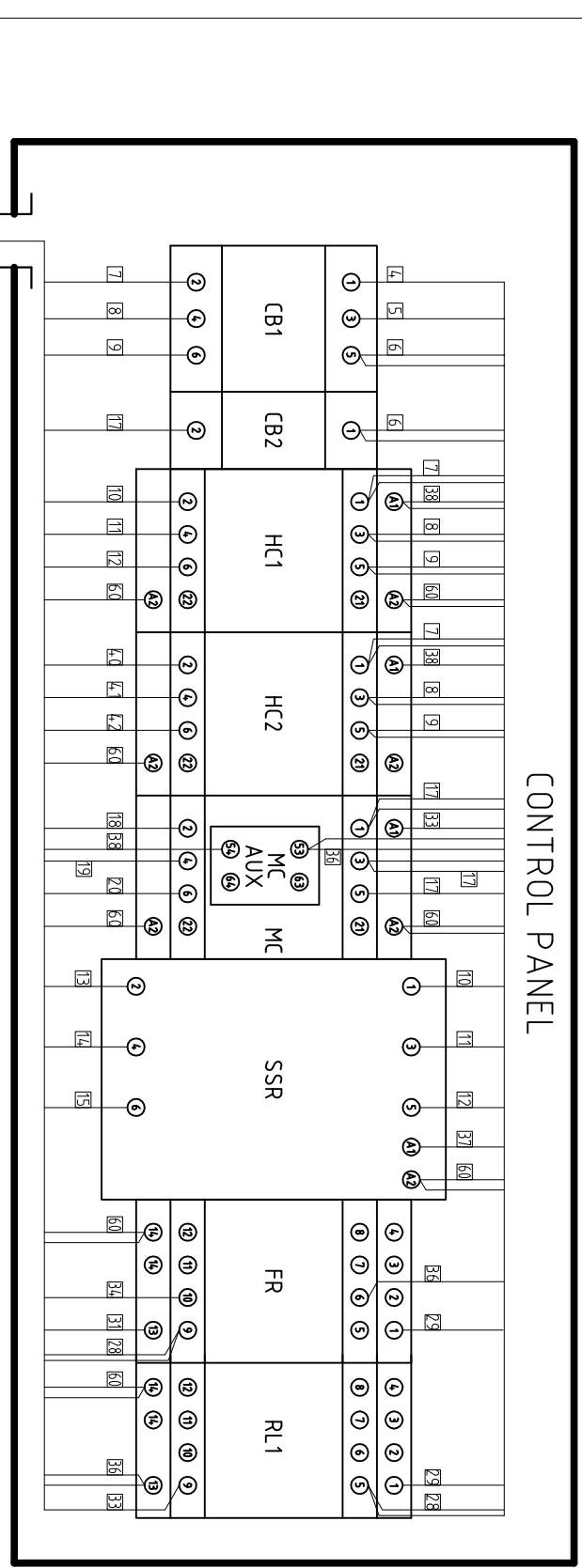
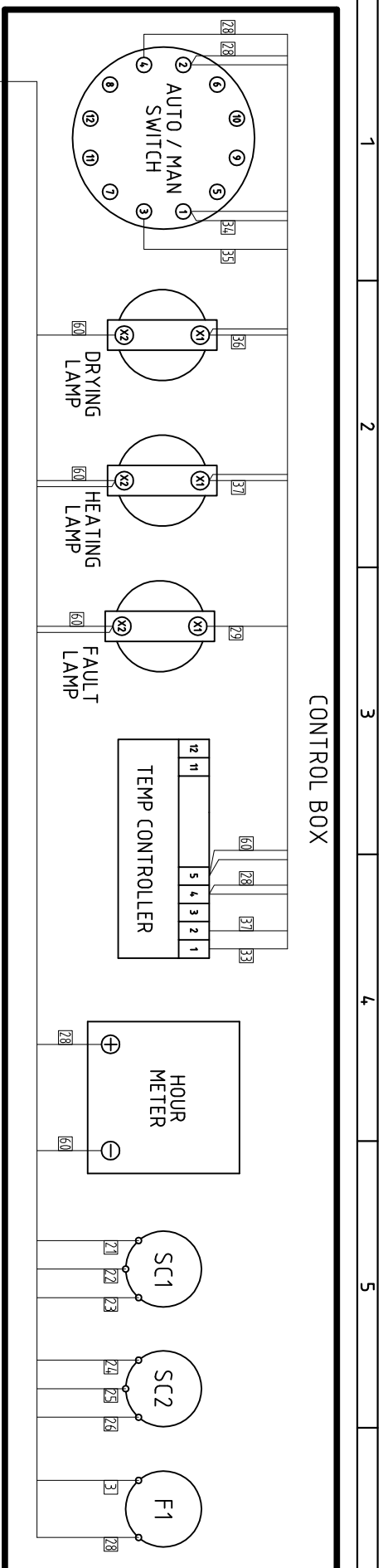

SEE SHEET 2 OF 2 FOR BETTER VIEW OF HEATER BOX

1993
LIMITED
BISHOP AUCKLAND
ENGLAND

TITLE
DD900 - WIRING DIAGRAM

MATERIAL
N/A

FINISH
N/A

3RD ANGLE PROJECTION
DO NOT SCALE
IF IN DOUBT ASK

DIMENSIONS IN mm.
TOLERANCES UNLESS OTHERWISE STATED

0.0	± 1
0.00	± 0.25
0.05	± 0.05
ANGULAR ±	0.5 DEGREE

DRG.NO.
5010321

DRAWN : W DAGLISH

CAD SCALE : N/A

SHEET
1 OF 2

ISSUE	DATE	AMENDMENTS
1	21/12/11	ORIGINAL
2	13/02/12	1ST PRODUCTION BUILD UPDATES - WDA
3	12/12/12	HEATERS CHANGED TO PTC HEATERS - WDA

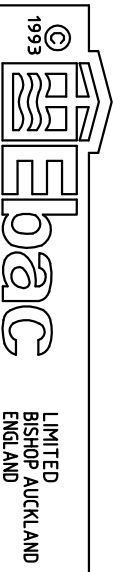
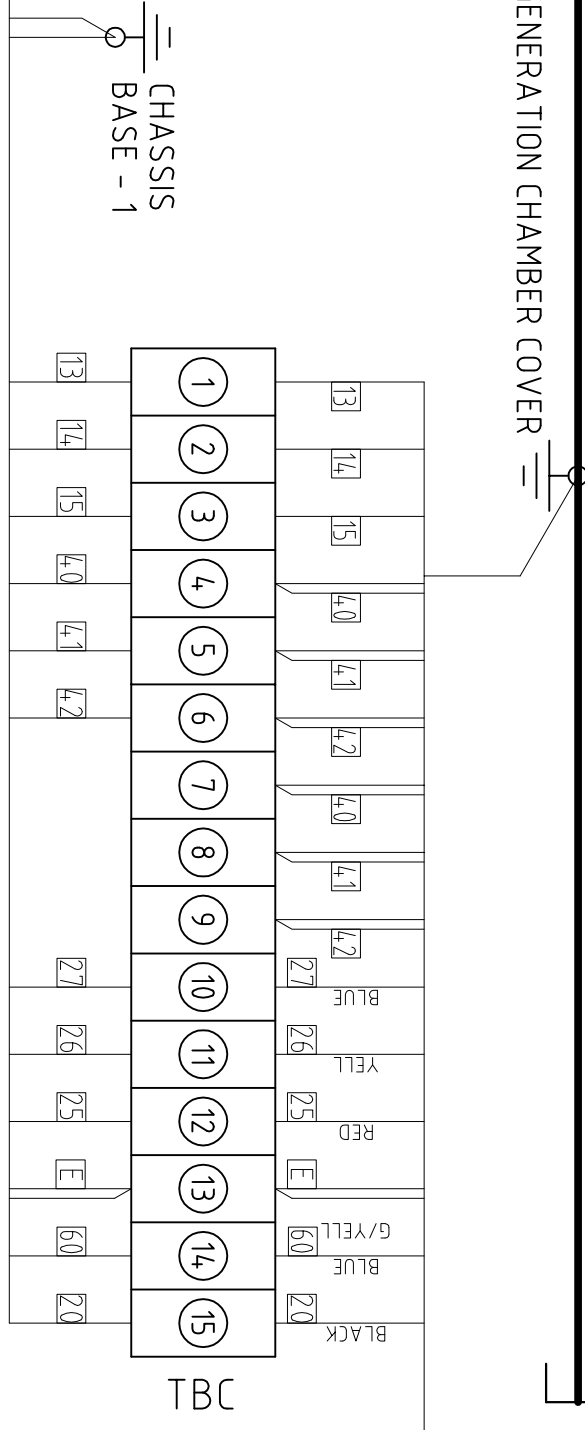
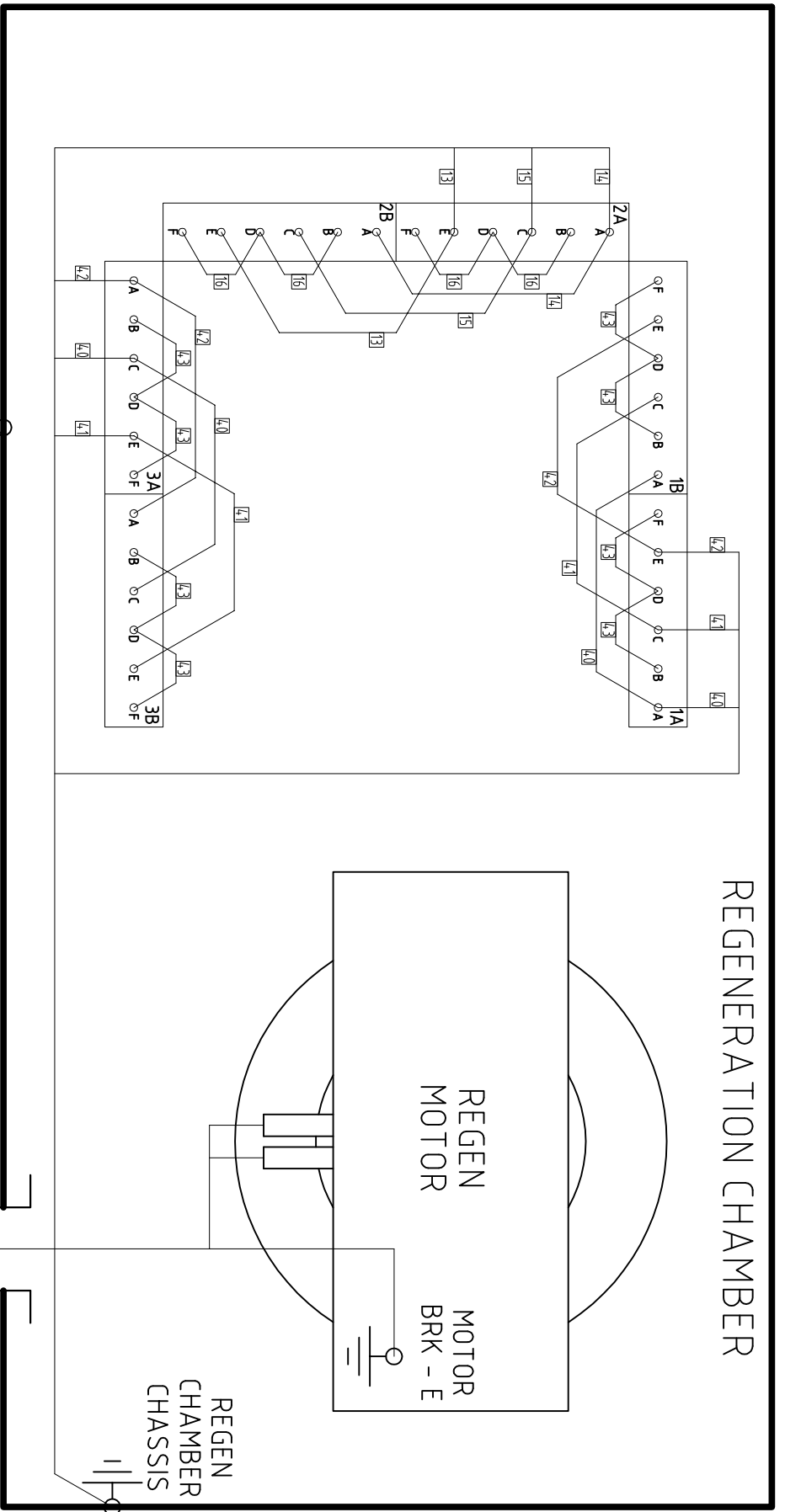

TITLE
DD900 - WIRING DIAGRAM

3RD ANGLE PROJECTION
DO NOT SCALE
IF IN DOUBT ASK

DIMENSIONS IN m.m.
TOLERANCES UNLESS
OTHERWISE STATED

0.0
0.00
ANGULAR ± 0.5 DEGREE

± 1
± 0.25
± 0.05

MATERIAL
N/A

FINISH
N/A

DRAWN : W DAGLISH
CAD SCALE : N/A

DRG.NO.
5010321

SHEET
2 OF 2