

# INDUSTRIAL DEHUMIDIFIER

MODEL: RM65

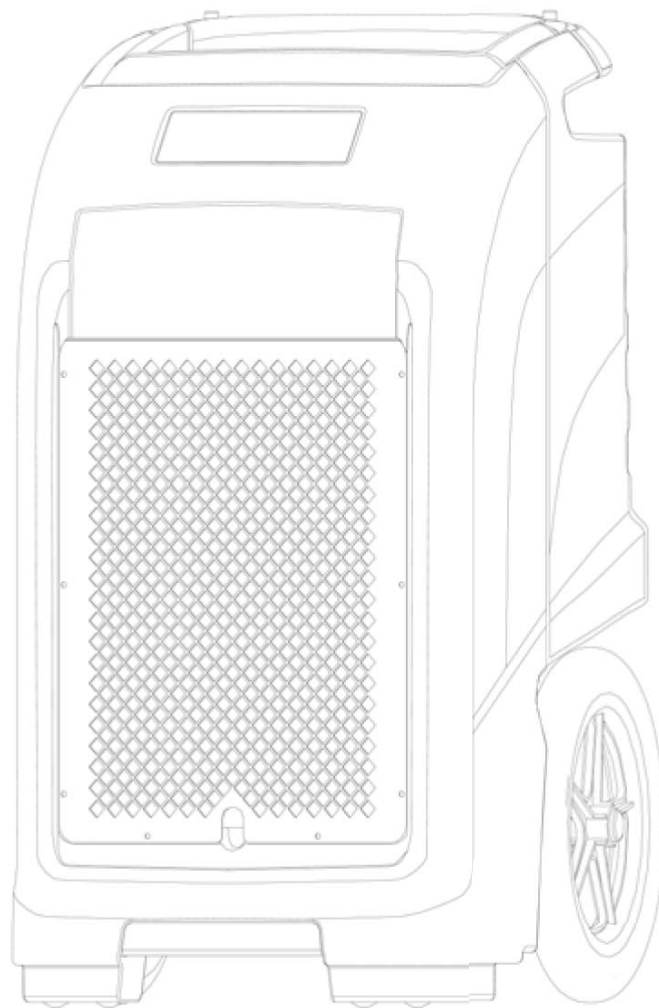

## INSTRUCTION MANUAL

SAVE THESE INSTRUCTIONS FOR FUTURE REFERENCE

# GENERAL INFORMATION

## Packaging

Please DO NOT dispose of any packaging until you have checked the appliance is operational.

After removing the packaging ensure the contents are intact and complete. In the unlikely event of missing parts; contact your retailer.

**DO NOT** leave children unattended with any of the packaging since it is a potential source of danger. Disposal of all packaging must be carried out responsibly & safely and in accordance with your local authority regulations.

ALWAYS recycle the packaging material where possible.

**When using any electrically powered product, basic safety precautions should always be followed.**

**PLEASE READ THE INSTRUCTIONS CAREFULLY AND IN FULL BEFORE USING THE PRODUCT.**

# IMPORTANT INSTRUCTIONS

**WARNING - to reduce the risk of fire, electrical shock or injury to persons or property:**

1. Always operate the product from a power source of the same voltage, frequency and rating as indicated on the product identification plate.
2. Close supervision is necessary when any product is used by or near children the elderly or the infirm. Do not allow children to use the appliance as a toy.
3. Do not operate this product with a damaged power cord plug. If the supply cord is damaged it must be replaced by qualified Ebac Industrial Products personnel or other similar qualified persons in order to avoid hazard.
4. To reduce the risk of electric shock, do not expose the unit or flexible cord to moisture of any kind.
5. Switch off and unplug from the power socket when not in use, before assembling or before cleaning.
6. Do not place objects on the product or allow objects to obstruct the inlet or outlet openings, or operate in close proximity to walls or curtains, etc.
7. The use of attachments or accessories not recommended or sold by the product distributor may cause injury to persons or damage to property.
8. This product is intended for normal light commercial use only.
9. Do not attempt to dismantle the appliance.
10. Do not operate the appliance on a metal surface.
11. Do not use the appliance in artificially hot or humid conditions or allow to be used in a hazardous environment.
12. Do not clean the appliance with organic solvent.
13. This appliance is not intended for use by persons (including children) with reduced physical, sensory or mental capabilities, or lack of experience and knowledge unless they have been given supervision or instruction concerning use of the appliance by a person responsible for their safety.
14. Children should not be left unsupervised with the appliance .
15. This instruction manual is an integral part of the appliance and should be stored for safe keeping and must always accompany the appliance in the event of ownership transfer or for reference to by a service engineer.

## READ AND SAVE THESE INSTRUCTIONS

## PRODUCT IDENTIFICATION

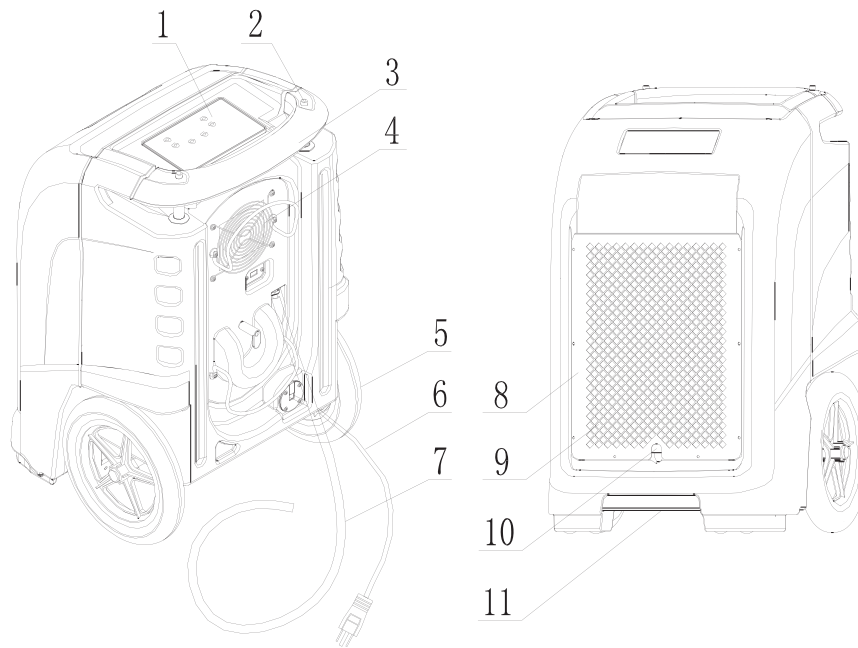

- 1 Control Panel
- 2 Handle Adjustment Button
- 3 Handle
- 4 Air Outlet
- 5 Wheels
- 6 Power Cord

- 7 Water Pipe
- 8 Air Inlet Grille
- 9 Air Inlet
- 10 Air Filter
- 11 Bucket Handle

### **WARNING**

**DO NOT OBSTRUCT THE AIR INLET OR OUTLET.**

## SETTING UP INSTRUCTIONS



### IMPORTANT

Place dehumidifier in the upright position. When transporting a dehumidifier to site, allow the dehumidifier to stand for 30 minutes before switching ON. This is necessary to allow the refrigerant system to stabilise and avoid system damage .

**SETTING UP THE DEHUMIDIFIER:** Operate the dehumidifier in an enclosed area, as this creates a drying chamber. Close all doors, windows or areas that open to external areas, to maximize the dehumidifier's water removal efficiency. Keep traffic through the drying chamber to a minimum. Place the dehumidifier in the centre of the room away from walls and furnishings. DO NOT allow the airflows to be obstructed.

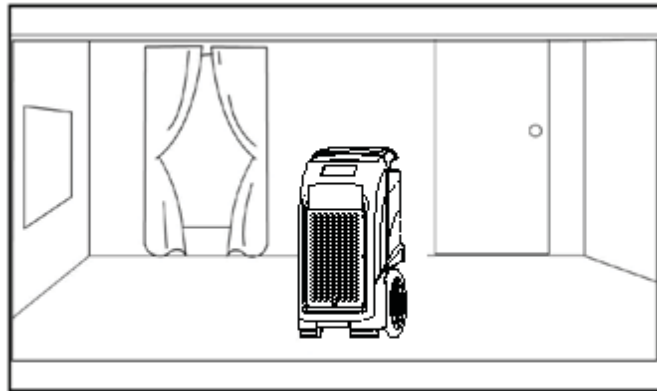

Illustration of correct positioning for best performance

**DRAINAGE:** The dehumidifier pump connects to a plastic drainage hose. The hose is stored on the back of the appliance. Uncoil the entire hose ensuring there are no kinks or restrictions and place the unattached end into a water vessel or run to outdoors.

Ensure that water which runs to outdoors does NOT create a slip hazard.

Water vessels MUST be checked regularly where used.

# CONTROL PANEL

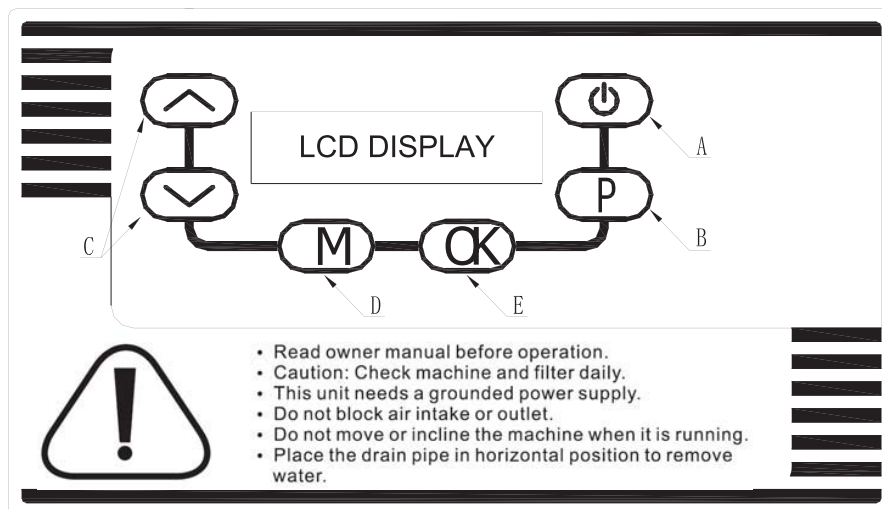

## Hour counters

Two digital hour counters are built-into the control system.

### • Cycle hour counter

This counter is reset when the dehumidifier is switched on and shows the accumulated working time of each job cycle. It is automatically displayed during the running mode and counts from 00:00 up to 99:60.

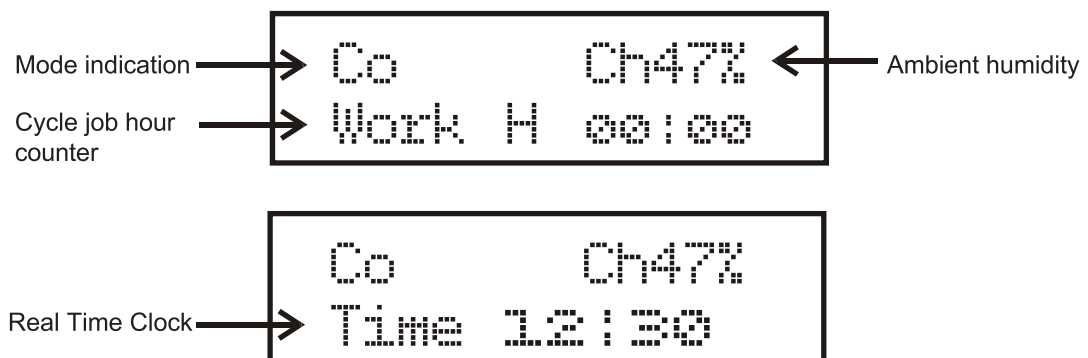













## CONTROL PANEL

- **Total hours counter (non-manual reset)**

This hour counter records the running time and cannot be reset. It is displayed during standby mode, counting from 0000 up to 9999 hours.



## FUNCTION KEYS

- A.  ON/OFF: Press once to turn the unit ON or OFF.
- B.  **PURGE**: Press the PURGE key to empty water from the pump reservoir. During normal operation the pump purges automatically when the reservoir is full. Use 'PURGE' before moving the machine to avoid water spillage. The pump will close automatically after forty seconds continuous operation.
- C.  and 
- I. Press  and  key to set or adjust humidity in the range between 26% and 90%. When the environmental humidity is below 26% "CO" will be displayed.
- II.  and  key is used to adjust set time.
- III.  and  key used to switch menu functions.
- D.  : Press the function key, the panel displays 'HUMID' - 'TIMER' - 'LOAD' - 'LANGUAGE'. Press ENTER to select sub menu. Repress ENTER key and after one minute the appliance will return to normal menu.
- E.  : Press the ENTER key to confirm menu selection.

## OPERATION USING THE CONTROL PANEL

### Operation in general use:

- I. Press the ON/OFF key to power the dehumidifier ON. The unit will operate automatically to set conditions.
- II. After use, press ON/OFF key to turn the power OFF. The water pump will turn on automatically for 40 seconds to drain the residual condensate water in the dehumidifier.

#### Attention:

**DO NOT** switch the power **OFF** by disconnecting at the mains socket outlet. To avoid water spillage; **DO NOT** move the dehumidifier for at least three minutes after turning the power **OFF**.

### Humidity setting

The factory setting is continuous. The humidity can be set in the following manner:

1. Press the **FUNCTION** key. The screen will display: Humid, Timer, Load, Langu R.

<b>H u m i d</b>	<b>T i m e r</b>
	<b>L a n g u e</b>
	<b>R</b>

2. Press the **FUNCTION** key again, and select "Humid".
3. Press "ENTER" and the screen will display:

<b>H u m i d</b>	<b>S e t t i n g</b>
<b>0 0 %</b>	<b>R</b>

4. Press "▲" and "▼" key, to select Relative Humidity between 26% and 90%
5. Press **ENTER** key to select desired setting.
6. Press **FUNCTION** key to select "R" and press the **ENTER** key or wait 10 seconds to turn back automatically. If you need return to acquiescent **RH** setting, choose a number below 26% then press **ENTER**.



## OPERATION USING THE CONTROL PANEL

### Timer:

1. Press the **FUNCTION** key. The screen will display: Humid, Timer, Load, Langu

<b>H u m i d</b>	<b>T i m e r</b>
	<b>L a n g u e</b>
	<b>R</b>

2. Press the **FUNCTION** key & select Timer
3. Press the **ENTER** key & the screen will display:

<b>C l o c k</b>	<b>T o n</b>
<b>T o f f</b>	<b>T I / O R</b>

4. Press the **FUNCTION** key & select clock.
5. Press the **ENTER** key & the screen will display:

<b>C l o c k</b>	<b>T</b>	<b>00:00</b>
<b>Y20000</b>	<b>M00</b>	<b>D00 R</b>

6. Press “▲” and “▼” key, select hours from 00 to 24.
7. Press the **ENTER** key to confirm.
8. The cursor turns to the next position automatically.
9. Press “▲” and “▼” key to select minutes from 0 to 59.
10. Press the **ENTER** key to confirm the number.
11. The cursor turns to the next position automatically.
12. Repeat process until the clock is completely set.
13. Once finished, move the cursor to ‘R’ and press the **ENTER** key to return to normal operating mode. The screen will display set time only.

**In the event that data requires modifying; use the cursor to reset.**

**The new data will not become active until the ENTER key is pressed.**

## OPERATION USING THE CONTROL PANEL

### Timer ON setting

Ensure the clock is correct before setting the timer.

1. Press the **FUNCTION** key & the screen displays:

H u m i d	T i m e r
	L a n g u e

2. Press the **FUNCTION** key again & select Timer
3. Press the **ENTER** key & the screen displays:

C l o c k	T o n
T o f f	T I / O R

4. Press the **FUNCTION** key again & select T on.
5. Press the **ENTER** key & the screen will display:

T i m e r	O n
0 0 : 0 0	O f f R

6. Press “▲” and “▼” keys to select from 00 to 24.
7. Press the **ENTER** key to confirm this number.
8. Press the **FUNCTION** key again & select minute position
9. Press “▲” and “▼” key & select from 00 to 59.
10. Press “**ENTER**” key to confirm this number.
11. Press the **FUNCTION** key again & ‘**Off**’ is displayed.
12. Press the **ENTER** key & ‘**On**’ is activated.
13. After setting is completed press the **FUNCTION** key again & move the cursor to “**R**” and press the **ENTER** key. The display will return to normal.

**To cancel the time display move the cursor to the ‘On’ position and press enter, turning it to Off. This function only performs once.**

## OPERATION USING THE CONTROL PANEL

### Timer OFF setting

Set the timer OFF in the same manner as timer ON

### Cycle timer setting

The screen displays:

O n	00 : 00	O f f
O f f	00 : 00	R

After setting the cycle timer the dehumidifier will turn **ON/OFF** at the selected times. The cycle is 24 hours.

**Pressing 'On/Off' during the Cycle timer operation will not automatically cancel the program.**

**The dehumidifier will not function if the timer ON and timer OFF times are the same.**

**To cancel the time display, press the ENTER key to change OFF to ON.**

### Language Option

The language option is not available for this model

## Maintenance CLEANING THE AIR FILTER

Ensure the dehumidifier is turned OFF and the 13 Amp plug is removed from the power socket before maintenance is carried out.

The working performance of the dehumidifier will be greatly reduced if the filters become blocked.

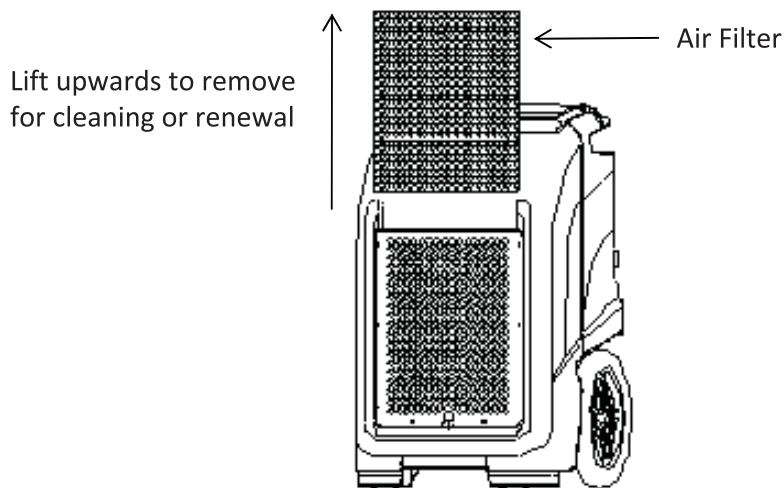

- I. Remove the filter as shown in the diagram above.
- II. Vacuum any debris from the filter using the vacuum hose and nozzle attachment.
- III. Using luke-warm water and a mild detergent wash the filter and allow to dry.
- IV. Once dry, re-install the filter into the dehumidifier.

## Maintenance REPLACING THE BATTERY

- I. Remove the screws in the four corners of the control panel.
- II. Once the screws are removed, carefully lift the control panel to access the PCB.
- III. On the PCB is a CR2032 battery. Remove the battery and replace with new.
- IV. Refit the control panel onto the PCB.
- V. Refit the four screws.

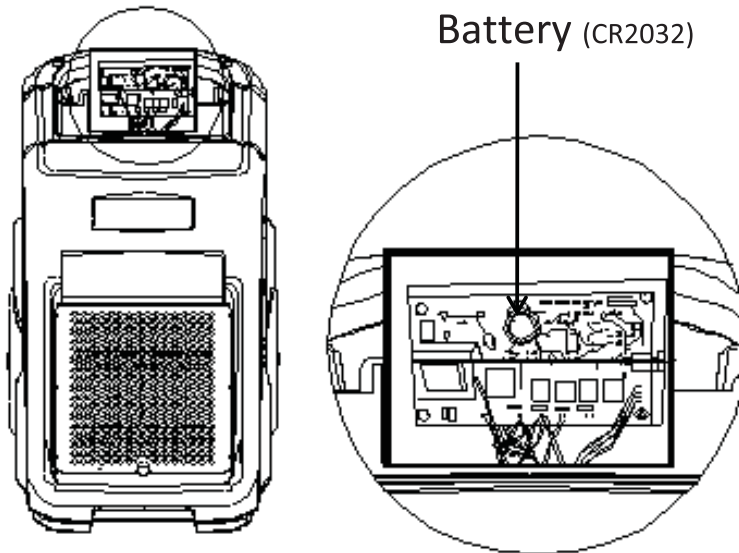

# TROUBLE SHOOTING

PROBLEM	CAUSE	SOLUTION
Dehumidifier does not operate	No Power to appliance	Connect plug to power socket
	Switch not turned on	Switch on
	E4 error is displayed	Check drainage flow
Dehumidifier collects little water	Insufficient working time	Allow more working time
	Filter is blocked	Clean filter
	Low ambient temperature	Increase ambient temperature
	Condensate hose is blocked	Check hose for restrictions
Dehumidifier is operating but room is not drying	Doors and windows are open	Seal room from external areas

## WARNING:

DO NOT attempt to rectify faults using unqualified personnel.

## TROUBLE SHOOTING FAULT CODES

### WARNING:

In the event of a fault code, contact your service agent.

CODE	E1	E2	E3	E4
<b>Error Message</b>	Coil sensor error	Humidity sensor error	Low or no refrigerant	Water pump fault or blockage
<b>Display Reading</b>	Flashes every 30 sec's	Flashes every 30 sec's	Flashes continually	Flashes continually
<b>Reason</b>	Timed defrost mode. The dehumidifier is working correctly.	50% R.H displayed Continuous mode in operation	Turn power OFF. Then turn ON again.	Dehumidifier will turn OFF automatically. The fault must be rectified before operation can commence.
<b>Display Area</b>	Top left corner	Bottom left corner	Top right corner	Bottom right corner

## SPECIFICATION

Model	10288GR-GB	10288GR-GE	10288GR-US
Water Removal Capacity	65L/day (30°C RH80%)	65L/day (30°C RH80%)	137 ppd (86°F RH80%)
	38L/day (27°C RH60%)	38L/day (27°C RH60%)	80 ppd (80°F RH60%)
Power Supply	230V/50Hz	230V/50Hz	115V/60Hz
Max Power	1080W	1080W	1080W
Max Current	4.6A	4.6A	9.2A
Rated Power	750W	750W	750W
Rated Current	3.3A	3.3A	6.6A
Refrigerant	R410a/560g	R410a/560g	R410a/20oz
Operating Range	5°C~32°C	5°C~32°C	40°F~90°F
Net Weight	37kg	37kg	80lbs
Dimension	485x510x810mm	485x510x810mm	Approx 19x20x32in

### UK Head Office

Ebac Industrial Products Ltd  
 St Helens Trading Estate  
 Bishop Auckland  
 County Durham  
 DL14 9AD  
 Tel:+44(0)1388 664400  
 Fax:+44(0)1388 662590  
 www.eipl.co.uk  
 sales@eipl.co.uk

### German Sales Office

Ebac Industrial Products Ltd  
 Miraustra 64-66  
 13509  
 Berlin  
 Germany  
 Tel:+49 3043 557241  
 Fax:+49 3043 557240  
 www.eip-ltd.de  
 sales@eip-ltd.de

### American Sales Office

Ebac Industrial Products Inc  
 700 Thimble Shoals Blvd  
 Suite 109, Newport News  
 Virginia, 23606-2575  
 USA  
 Tel:+01 757 873 6800  
 Fax:+01 757 873 3632  
 www.ebacusa.com  
 sales@ebacusa.com

